

APIJUNEDA CATALOG OF BEEKEEPING CLAMPS



Model V



Model NV



Model Multi

IMAGE 1

INDEX

INTRODUCTION

<u>CLAMP MULTI</u>	<u>p. 1</u>
<u>OPCIONES</u>	<u>p.2</u>
<u>CLAMP NV</u>	<u>p. 3</u>
<u>CLAMP V</u>	<u>p. 4</u>
<u>CLAMPS ON ORDER</u>	<u>p. 5</u>

CLAMPS MODEL MULTI



[inches] mm Weight: 20 kg / 44 Lb Capacity: 200 kg / 441 Lb

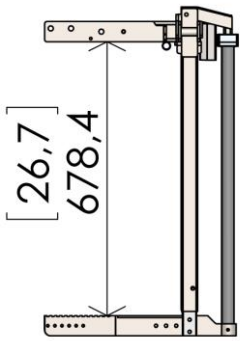

DIMENSION CLOSED
FOR (49,9) In 1267 Open

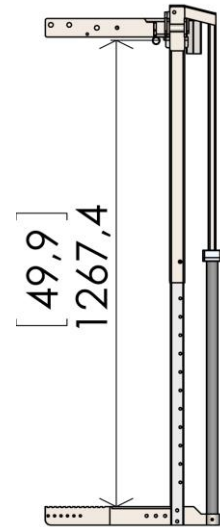
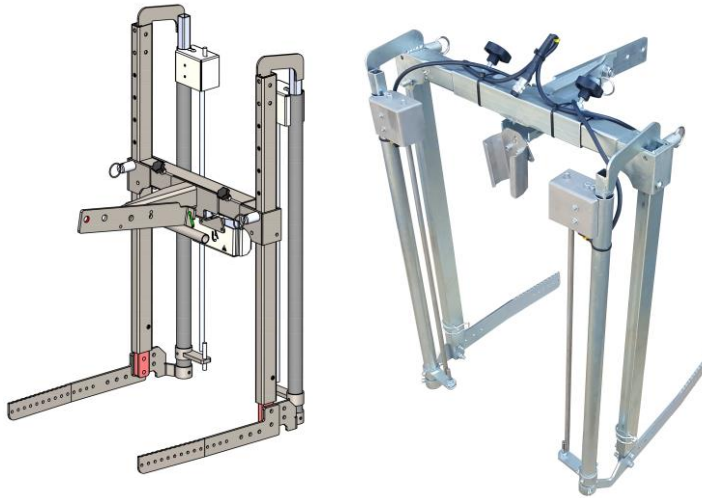

(63,05) In, 1600 mm ON REQUEST

DESCRIPTION:

- ✓ MULTI clamps have been designed to perform all weight management tasks in the apiary.
- ✓ Its vertical arms provide comfort and ergonomics.
- ✓ MULTI clamps are adjustable in height and width to adapt to all hives on the market.
- ✓ **Multi clamps are delivered as seen in the image above, optional accessories are explained in this document and must be selected in the order form.**
- ✓ From the clamp bars, in all their height you have the control of the most important functions. Up fast, Down fast, Up slow, Down slow, Brake, Unbrake, and Level.
- ✓ *We have given the maximum possible height for his load capacity. But we know that there are customers who prefer it with less height, but retaining the model's properties. For this reason it is possible to reduce its height easily just by cutting the vertical arms.*

(indicate on the order form if you want that we make this reduction)

USES:

On pallet

Flat Hives

Column Stand. Arms
In (49,9) 1267 mm

Column B-L Arms
In (63,05) 1600 mm

Harvest Supers

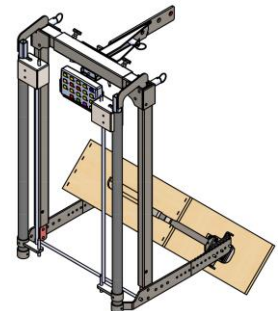
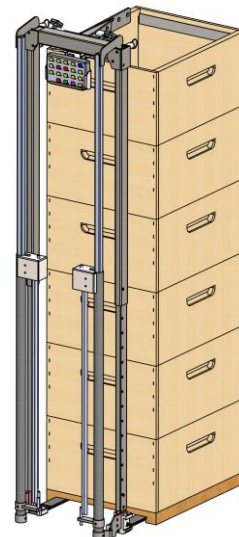
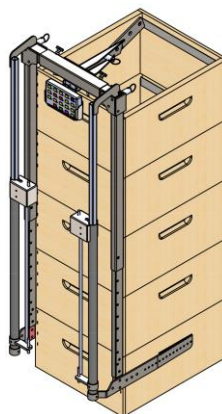
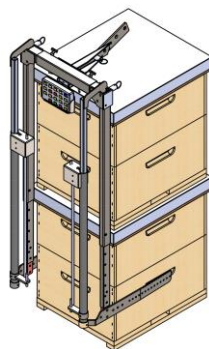
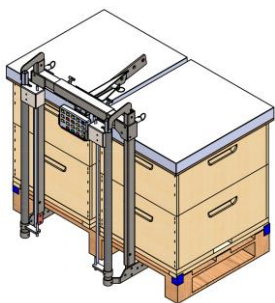

- Fixed right arm at 90°.
- Left arm oscillating, can be limited.
- Adjustable vertical and horizontal distance.

DETAILS:

- 5 main functions in the tactile rods.
- Security press.
- Oscillation of the press are lockable.



WITH STANDARD FORKS: (1)

With the arms delivered as standard, the clamps can be configured with the options as shown in the images.

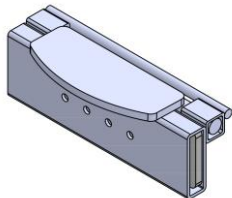
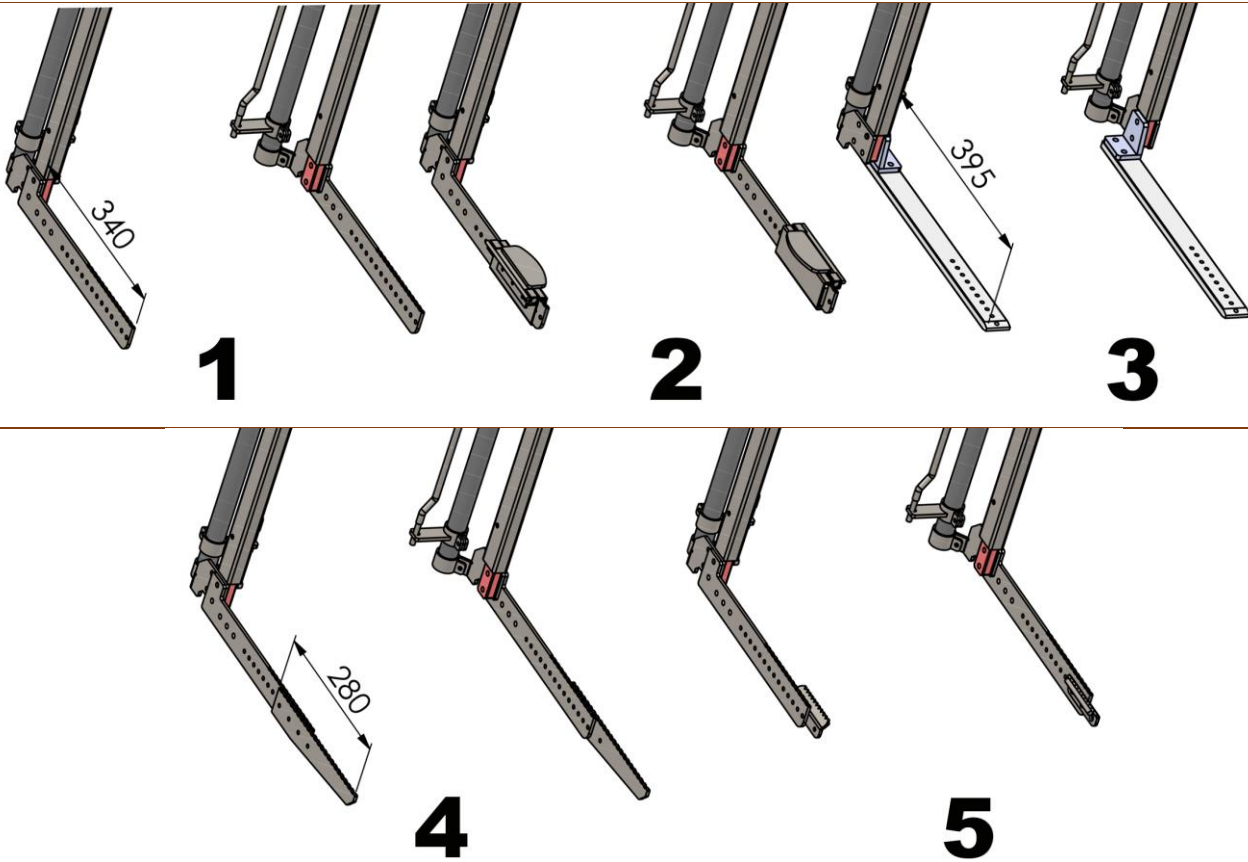

FLAT SYSTEM: (2)

To lift hives, supers or supers pile.

The arms work at a fixed distance, the plates are raised alone when touching the rise and position themselves to coincide with the hollow of the hands.

VALID: Multi

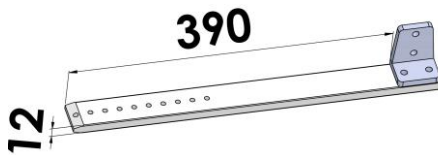

B-L SYSTEM: (3)

This system allows to mount horizontal arms to catch hives from the bottom.

A set screw presses each arm to prevent.

If you order the B-L system, you will also receive the standard arms.

VALID: Multi

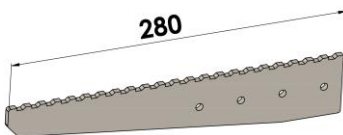

EXTENSION OF THE STANDARD ARMS: (4)

Select these parts if you use iron pallets and the Standard arms do not reach the pallet rails. The wooden pallets have boards in the middle that are sufficient to support and balance the load without extension, with the clamp press, arms as long as the hive are not necessary.

VALID: Multi, NV, V.



GR SYSTEM: (5)

They can be installed directly on the arms. To lift hives, supers or supers pile.

The left arm must be unlocked to work like a clamp.

The round piece allows the assembly to slide until it finds the hand hole,

then the serrated piece makes a firm grip.

VALID: Multi, NV, V.

CLAMP MODEL NV



[inches] mm weight: 17 KG/ 37,5 Lb Capacity: 200 Kg / 441 Lb

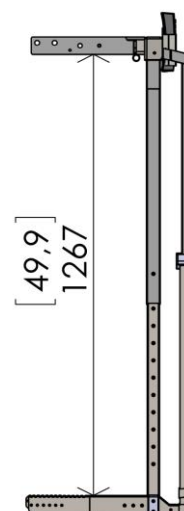
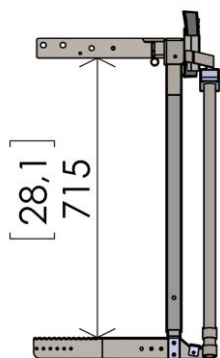

DESCRIPTION:

- ✓ NV clamps have been designed to perform all weight management tasks in the apiary.
- ✓ **NV clamps are delivered as seen in the image 1, optional accessories are explained in this document and must be selected in the order form.**
- ✓ From the clamp bars, in all their height you have the control of the most important functions. Up fast, Down fast, Up slow, Gown slow, Brake, Unbrake, and Level.
- ✓ We have given the maximum possible height for his load capacity. But we know that there are customers who prefer it with less height, but retaining the model's properties. For this reason it is possible to reduce its height easily just by cutting the vertical arms.
- ✓ (indicate on the order form if you want that we make this reduction)

USES:

Beehives on pallet

Flat hives without pallets

Supers pile

Harvest of supers

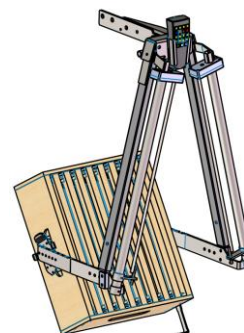
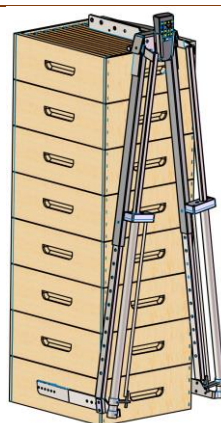
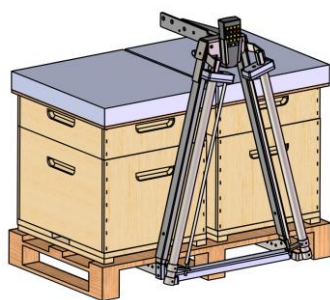

- Arms with limitable and lockable oscillation
- Adjustable vertical distance.
- 5 main functions in the tactile rods.

DETAILS:

- Security press.
- Oscillation of the press are lockable.



(inches) mm

Weight: 9 KG / 18,8 Lb

Capacity: 150 Kg / 330 Lb



DESCRIPTION:

- ✓ The V clamps were designed to perform all tasks in beekeeping work.
- ✓ **V clamps are delivered as seen in the image 1, optional accessories are explained in this document and must be selected in the order form.**
- ✓ From the buttons, without leaving the hands of the supports has the following functions:
Up fast, Down fast, Up slow, Down slow, Brake, Unbrake, and Level.

SOME USES:

Beehives on pallet

Flat hives without pallets

Supers pile

Harvest of supers

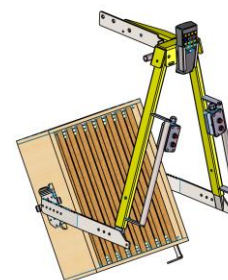
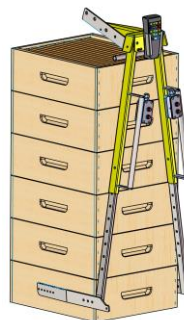
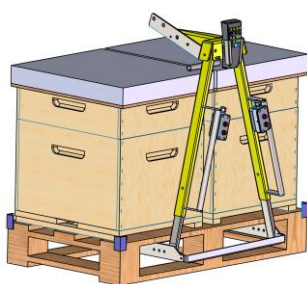

DETAILS:

- Arms with limitable and lockable oscillation
- Adjustable vertical distance.
- 5 main functions in the buttons
- Security press.
- Oscillation of the press are lockable.



SPECIAL MODELS

DESCRIPTION:

Some customers want particular clamps for different reasons.

We are open to any proposal and we adapt the functions of the crane to its clamp model.

Up fast, Down fast, Up slow, Down slow, Brake, Unbrake, and Level.



SOME USES:

Beehives on pallet

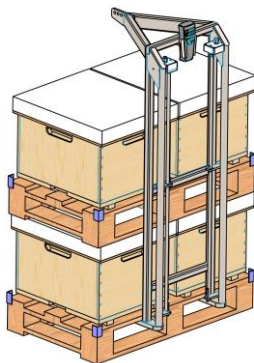

Flat hives without pallets



Supers pile



DETAILS:

- 5 main functions in the tactile rods
- Fixed height
- Functions available throughout the height of the clamp.
- Fixed width

PALLET OPTIONS:

